

Application Note AN2020

D-Series / C-Series

Positioning with Dimetix distance sensor and SEW inverter

V 1.08

Please check www.dimetix.com
for the latest version

Abstract

This application describes how to use the D-Series and C-Series laser sensor in a positioning application in conjunction with a SEW servo drive. The necessary configuration of the D-Series and C-Series laser sensor and the SEW inverter are described in this document. Further the wiring is also documented.

This application note is provided as is without any warranty for any problems this sample may cause.



Table of content

1 Document scope	3
2 Safety instructions	3
3 Introduction	3
3.1 SEW system requirements.....	4
4 Sensor setup	4
4.1 D-Series sensor.....	4
4.2 FLS-C sensor.....	6
4.3 Error handling MOVITOOLS® MOTION STUDIO.....	11
4.4 Error handling PLC.....	11
5 MOVIDRIVE® B setup for D-Series and C-Series	12
6 MOVIAXIS® setup for D-Series and C-Series	14



1 Document scope

This document covers an Application Note written for the Dimetix D-Series Laser Distance Sensors. The following topics are discussed:

- Safety instructions
- Application Note descriptions

2 Safety instructions



This Application Note is written for qualified system integrators to help doing an application specific sensor configuration. Before using the D-Series sensor also the safety related information in the D-Series Technical Reference Manual must be considered.



Looking into the laser beam may be hazardous to the eyes.

- Do not look into the laser beam. Make sure the laser is aimed above or below eye level. (particularly with fixed installations, in machines, etc.).



Take precaution against electrostatic discharge (ESD) when the D-Series laser distance sensors exchangeable cover is open.

- Generally the sensor with removed exchangeable cover is a sensitive device and can be damaged by electrostatic discharge.
- Only handle the device properly grounded and with care.
- No warranty will be granted on improper handling and / or ESD caused problems.

3 Introduction

The laser distance sensor measures absolute distances. It is suitable for positioning applications to measure the actual feedback position. Figure 1 shows a general setup for such an application.

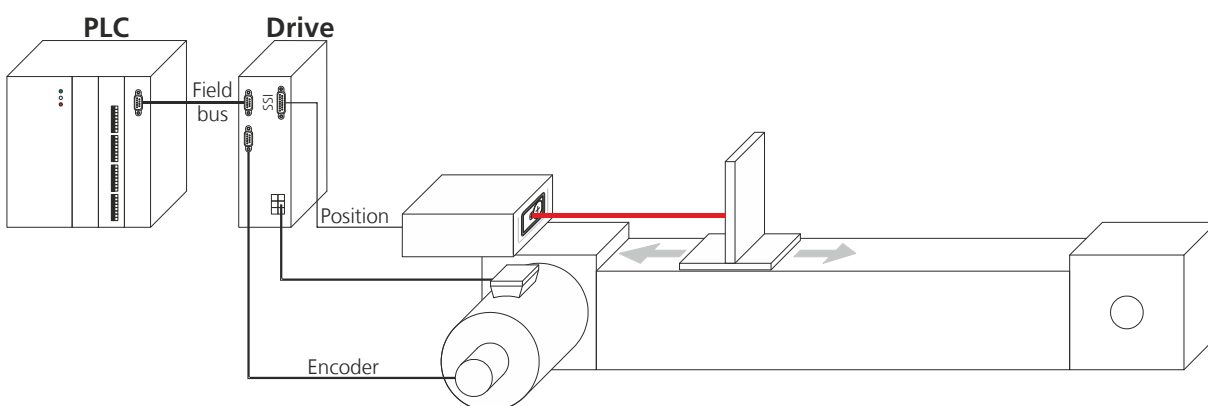

Fig. 1: Positioning application

In this Application Note a SEW Eurodrive inverter is used to control the motor. The position is measured by a D-Series or C-Series sensor of Dimetix. The setup of the sensor, the cable connection and the configuration of two product series (MOVIDRIVE® B, MOVIAXIS®) are described.



3.1 SEW system requirements

Hardware:	MOVIDRIVE® B with encoder card DEU 21B or MOVIAXIS® with encoder card XGS	
Firmware versions:	MOVIDRIVE® B	≥ 18220916.15
	MOVIAXIS®	≥ .28
	DEU21B	≥ .11
	XGS	≥ .12
	MOVITOOLS® MOTION STUDIO	≥ 5.80 SP2 (Service-Pack2)

4 Sensor setup

This chapter is a step by step configuration example. Just do each single step described later in this to configure the sensor for the positioning application. For the C-Series sensor please jump to chapter 4.2.

4.1 D-Series sensor

This chapter is applicable for D-series sensors.

4.1.1 Preparation

Before proceeding, it is recommended to reset the sensor to its factory defaults. But keep in mind that all previously done settings will be lost when performing a factory reset.

Steps	Description
1	Switch off the power supply used for the device
2	Press the reset push button and keep it pressed
3	Switch on the power supply used for the device
4	Keep the reset push button pressed until all status LED's (POWER, ERROR, DO1, DO2) flash for a short time (about 0.5 seconds)
5	Release the reset push button
6	Switch off the power supply and wait 5 seconds
7	Switch on the power supply and wait until the green status LED (POWER) is on
8	Reset procedure executed successfully

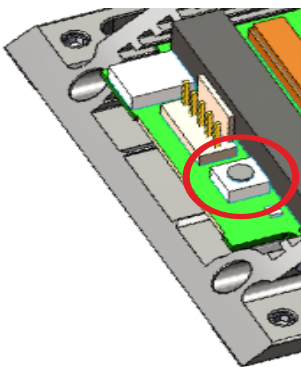
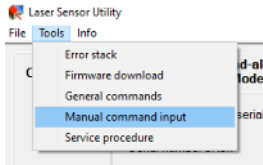
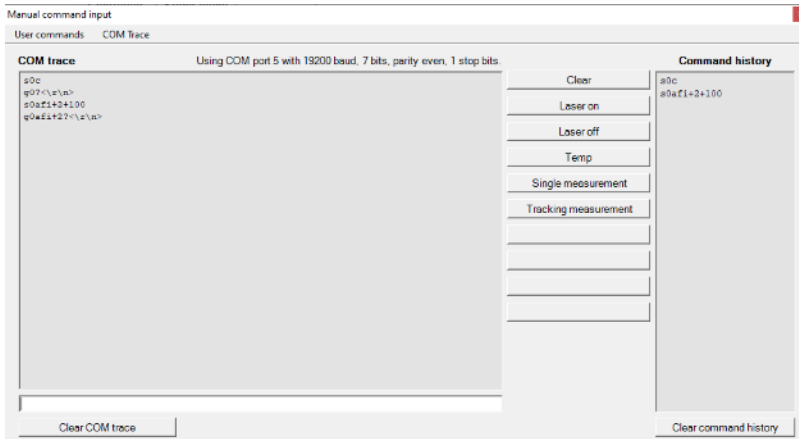

Fig. 2: Reset push button



4.1.2 Configuration

Steps	Description
1	Connect the laser sensor over USB or RS-232 to the PC, start the Laser Sensor Utility software and check the connection. Download and install the latest "Laser Sensor Utility" software (www.dimetix.com/UtilitySW).
2	If the SSI frequency only works at 125kHz , please download the special firmware file in step 2a . Otherwise, if the SSI frequency is higher than 125kHz (recommended is 1MHz) jump to step 3 .
2a	Download the special interface board firmware for the sensor (only for SSI with 125kHz): a) Menu Tools → Firmware download → Download interface board firmware file b) Select the following firmware file: "Dseries_IF_FW_V99_11_PAR_V2_SSI_RevisedStartSequence.dls" c) Wait until download is finished and sensor is reconnected d) Close the download window
3	Download the configuration file "Dserie_10_SEW_24012023.cfg" with the "Laser Sensor Utility". Therefore click on Menu File → Download configuration file to device.
4	Select the configuration file: "Dserie_10_SEW_24012023.cfg"
5	Test the sensor with the SEW-System. If the measurements are not accurate enough for your control unit, a special filter can be activated: see steps 6-8.
6 optional	Connect the sensor again with the Laser Sensor Utility. If needed, set the special moving target filter length. Therefore click on Menu Tools → Manual command input 
7 optional	Activate the special filter with the command: → Send: s0c ← Answer: <i>g0?</i> → Send: s0afi+2+100 (100 is the filter length, filter length range: 1...400) ← Answer: <i>g0afi+2?</i> → Send: s0A+0 
8 optional	Close manual command window and try again. If needed, adjust the filter length s0afi+2+xxx with an other value (see steps 6-8)



4.1.3 Connection

The D-Series sensor must be connected to the DEU21B/XGS of the MOVIDRIVE® B or the MOVIAXIS®. Connect the D-Series sensor with the internal screw terminal.

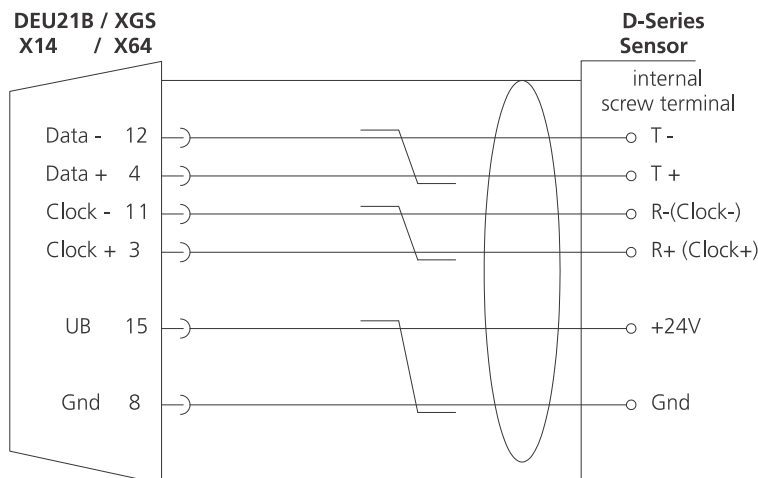

Fig. 3: Connection from D-Sub to screw terminal

4.1.4 Error handling

In the configuration for the D-Series Sensor the error behavior “Latest valid measurement value” is selected. In an error case (e.g. distance out or range E234) the last valid measurement is frozen until the sensor can measure again (without an error).

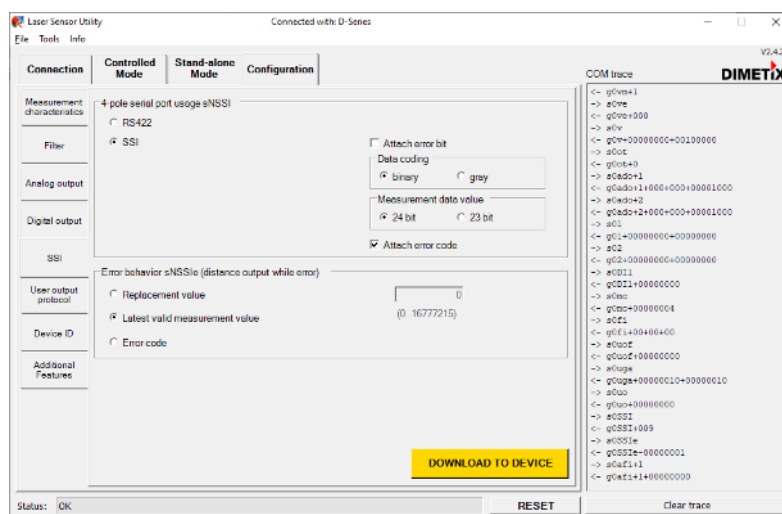

Fig. 4: Latest valid measurement value is selected

4.2 FLS-C sensor

This chapter is applicable for C-series sensors e.g. FLS-C.

4.2.1 Preparation

1. The following items are needed to do the configuration for the FLS-C.
 - o RS-232 Configuration cable FLS / DLS (Part no. 500200)
 - o 24V DC Power supply
2. Download the UtilitySW from the website www.dimetix.com/lnk/sew and install it on a PC.
3. Download the configuration file and save it on the PC.



4.2.2 Configuration

To setup the FLS-C sensor, connect the sensor to a serial interface of a PC and power the sensor with 24VDC. Start the UtilitySW and follow the steps below.

- Check the connection to the sensor

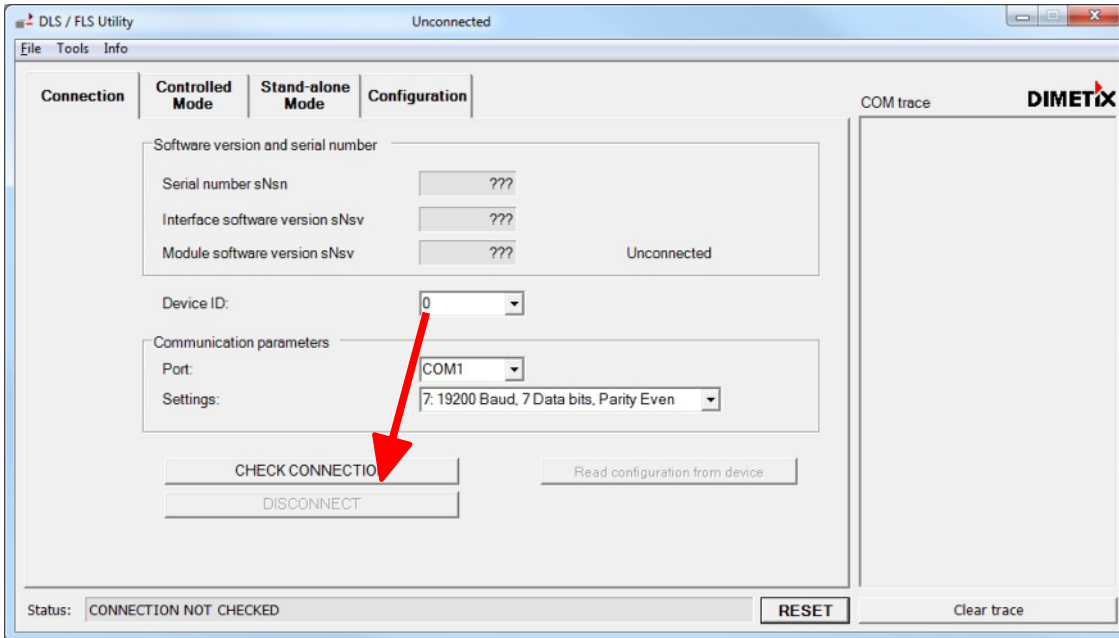

- The UtilitySW shows information about the sensor:

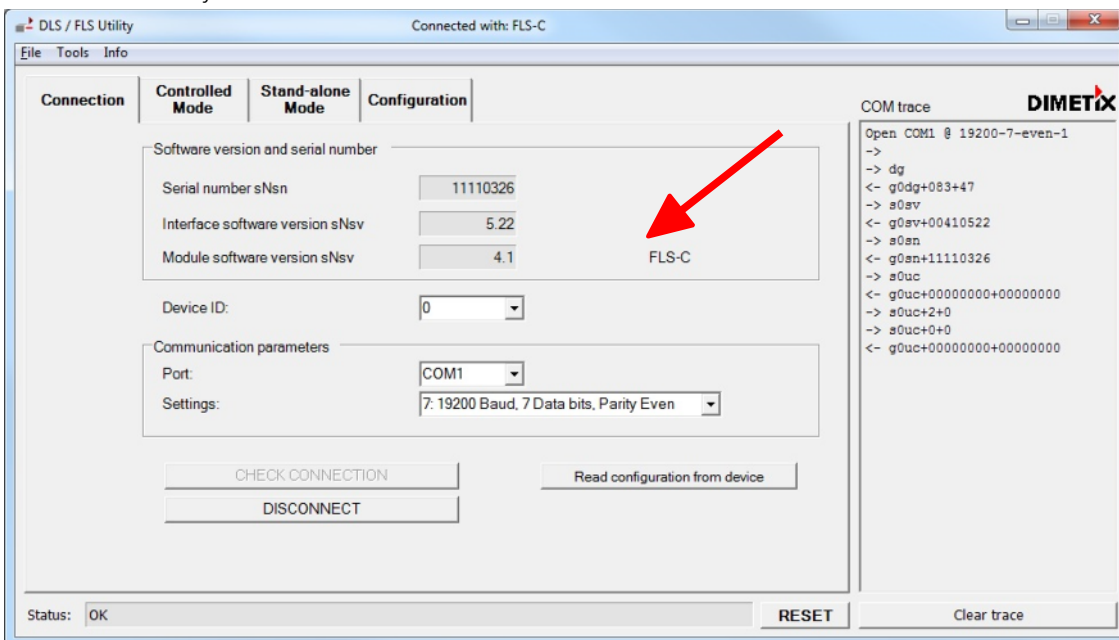

- Select File/Download configuration file to device

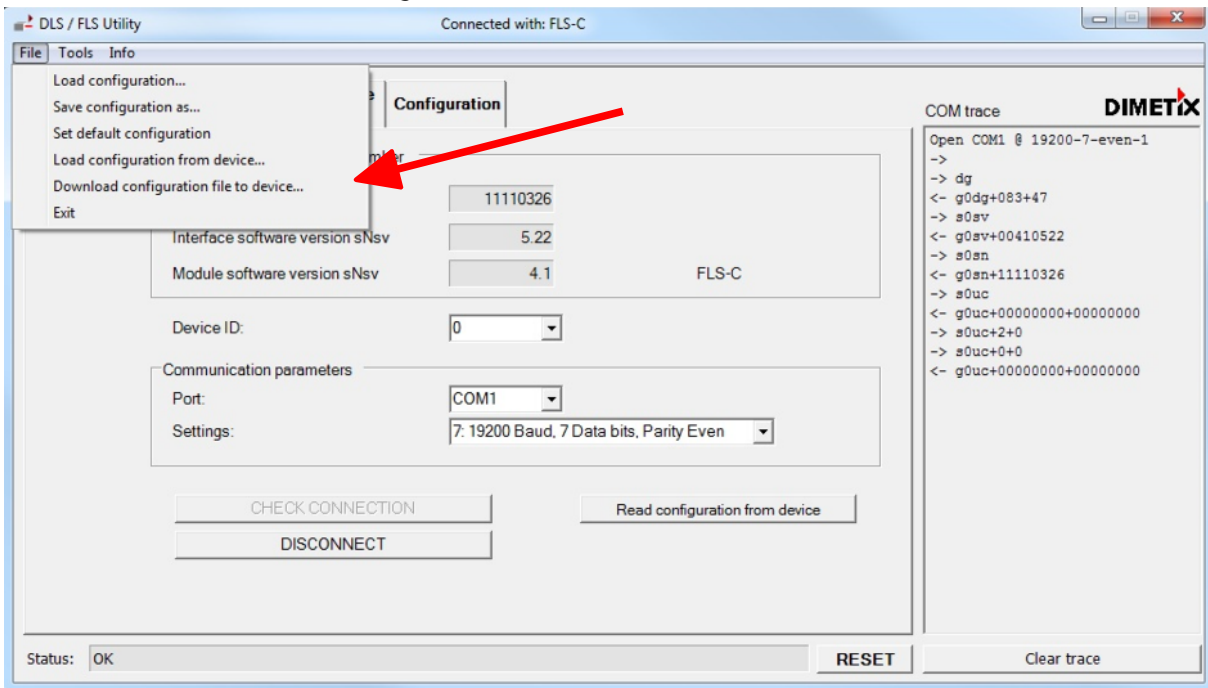

- Select the file "FLS_C_10_SEW_25072012.cfg". This is the file you downloaded in chapter 4.2.1 Preparation.

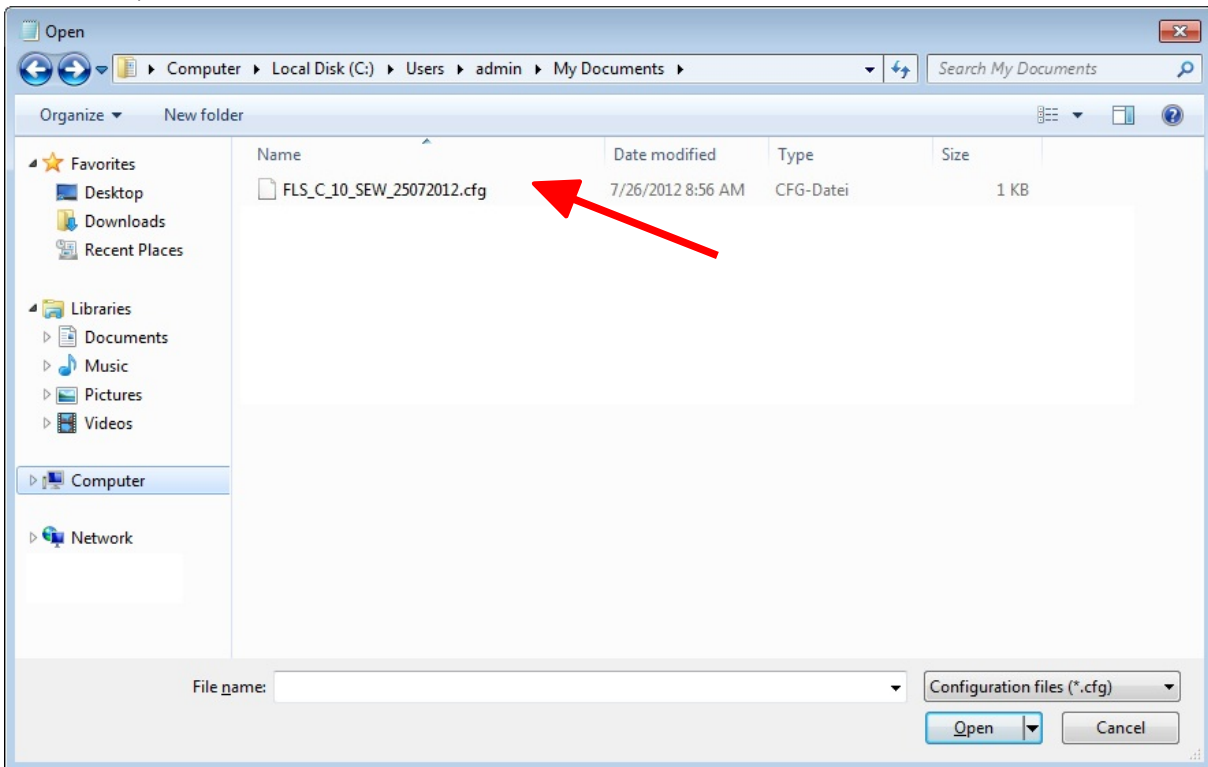

4 Sensor setup

- An OK in the status line of the UtilitySW indicates a successful transfer of the configuration. The FLS-C 10 is now ready to be connected to the SEW inverter.

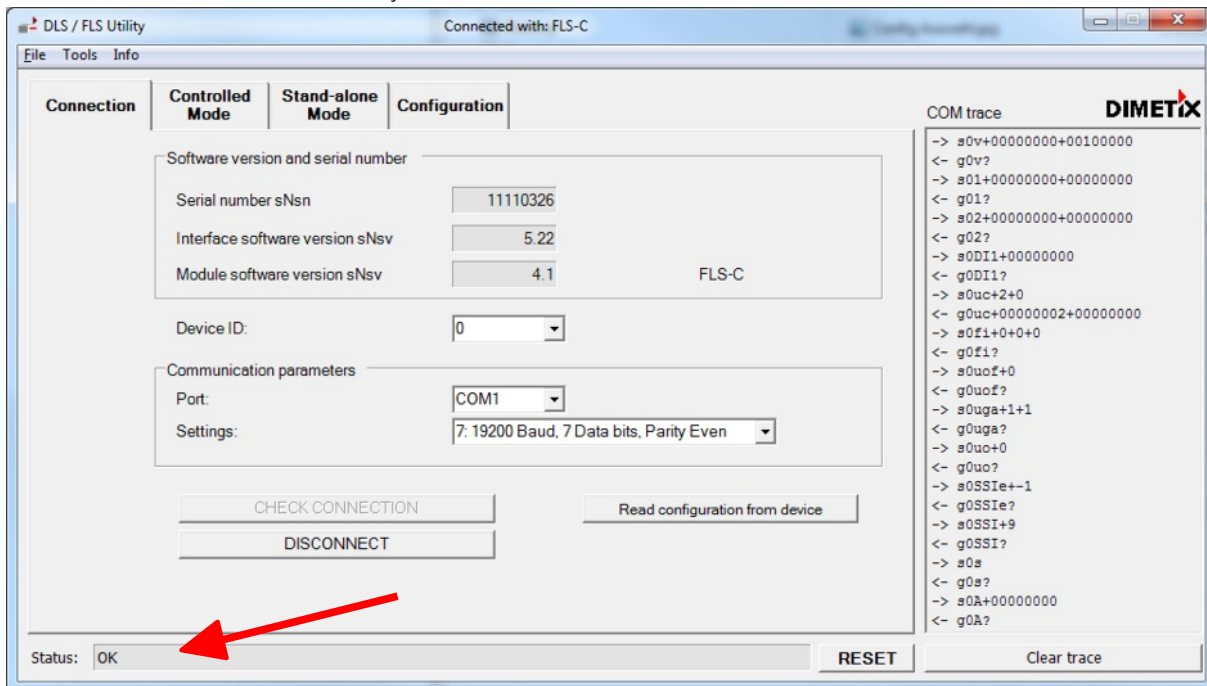

4.2.3 Connection

The FLS-C sensor must be connected to the DEU21B/XGS of the MOVIDRIVE® B or the MOVIAXIS®. Following different possibilities are documented. Connect the FLS-C sensor with a 15 pin D-sub connector or an internal screw terminal.

Connection of FLS-C (without heating)

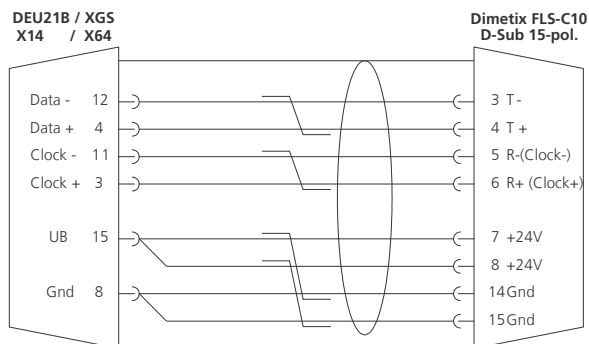

Fig 1: Connection from D-Sub to D-Sub

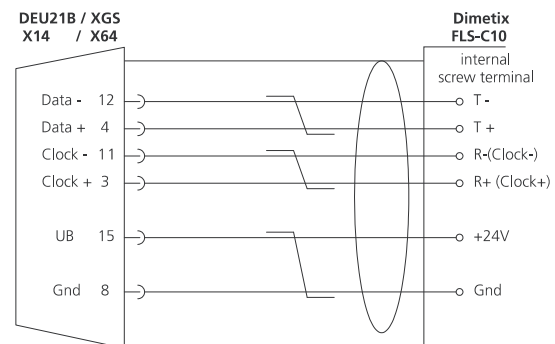

Fig 2: Connection from D-Sub to screw terminal

Connection of the FLS-CH (with heating)

If using a FLS-CH device with integrated heater, an external power supply must be used. Please do the wiring as shown in the following diagram.



The FLS-CH includes a heater and therefore the current consumption is up to 2.5A. As a result, the supply of power from the DEU21B/XGS is not possible.



4 Sensor setup

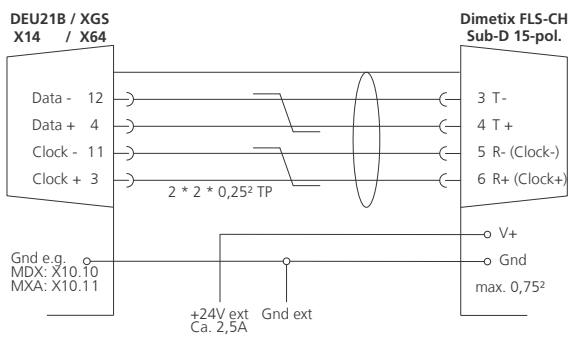

Fig 3: Connection from D-Sub to D-Sub

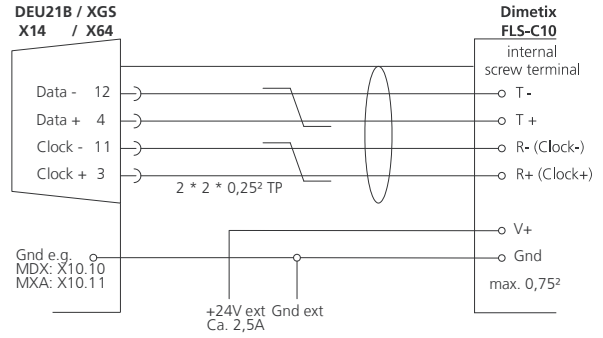

Fig 4: Connection from D-Sub to screw terminal



Install a proper ground connection between the ground of the FLS-C and the MOVIDRIVE® B / MOVIAXIS®.

4.2.4 Error handling

In the configuration for the FLS-C “With error freezing” is selected. Therefore an error (e.g. a position jump) will be detected. The sensor will be in the error state for about 5 s before it automatically does a reset.

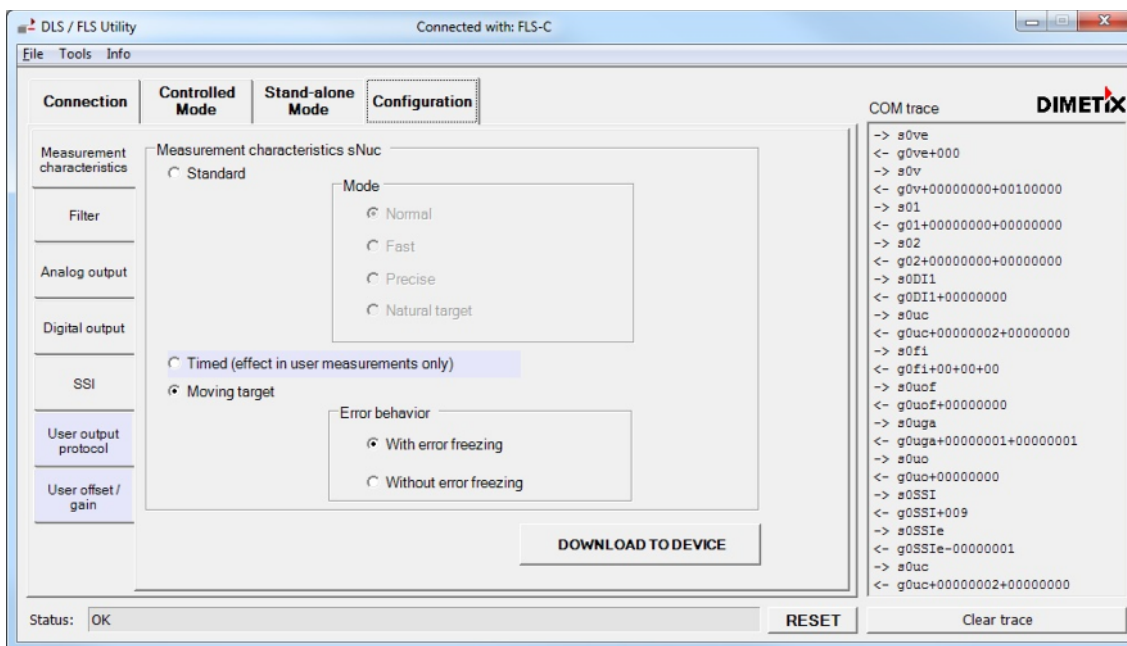

4.3 Error handling MOVITOOLS® MOTION STUDIO

The MOVIDRIVE® B-inverter registers errors of the FLS-C Distance Sensor. Examine them in the Fault History of the inverter.

To display the error with the MOVITOOLS® MOTION STUDIO, change the settings of the MOVITOOLS® MOTION STUDIO to 'Internal mode'.

Activate this mode under Settings / Authorization level: Password = *****) -> OK.

1) To get the code, you may ask Dimetix (sales@dimetix.com).

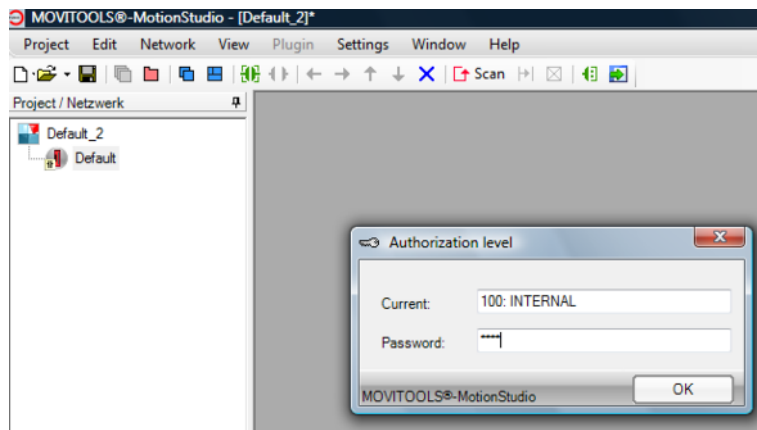

The encoder diagnostics via MOVITOOLS® MOTION STUDIO or PLC is only available with MOVIDRIVE® B. MOVIAXIS® does not support this function.

The field 080 Developer code shows the error code. Add 200_{dec} to the displayed value to get the error code corresponding to the FLS-C Distance Sensor reference Manual.

In this example, the fault memory 0 (last fault) is shown in the picture.

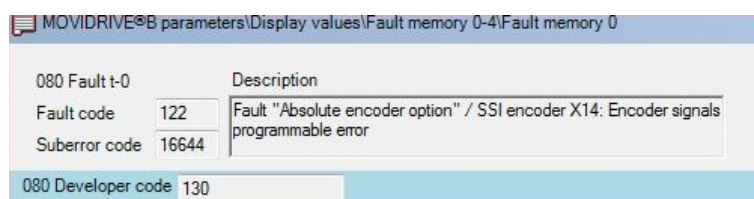

The field 080 Developer code is 130. Add 200 to it to get error 330, which corresponds to the Dimetix Error 330 Distance jump.

4.4 Error handling PLC

Read out the error code with the parameter service of the PLC:

- Read the index 8883.0 of the MOVIDRIVE® B for remote diagnosis.
Add 200_{dec} to get the error code corresponding to the Dimetix error list.



5 MOVIDRIVE® B setup for D-Series and C-Series

GUI: Encoder start-up

- Select distance measurement device

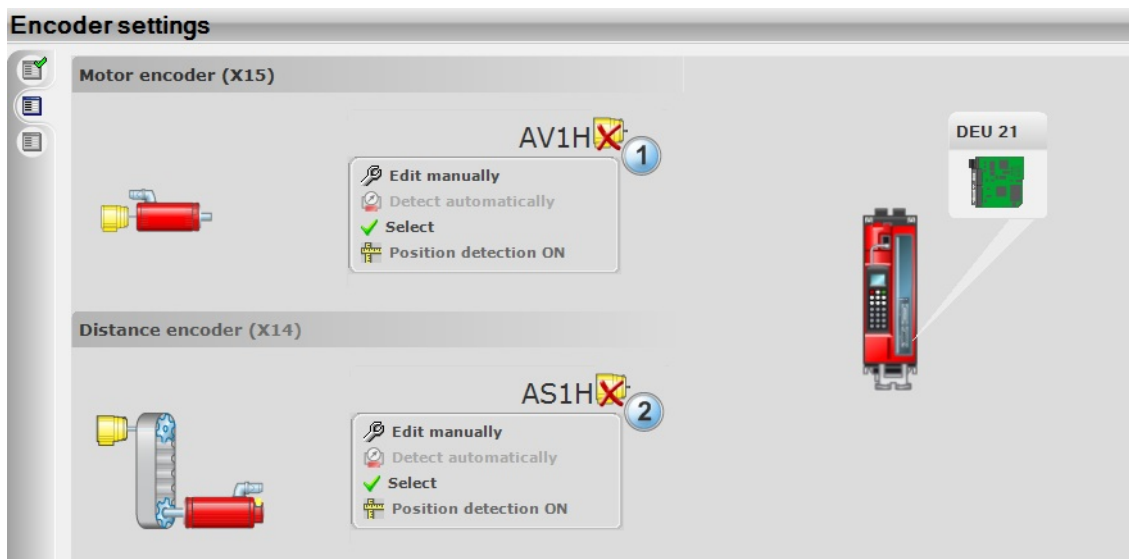

- Select 'FLS-C 10 Dimetix' as your encoder

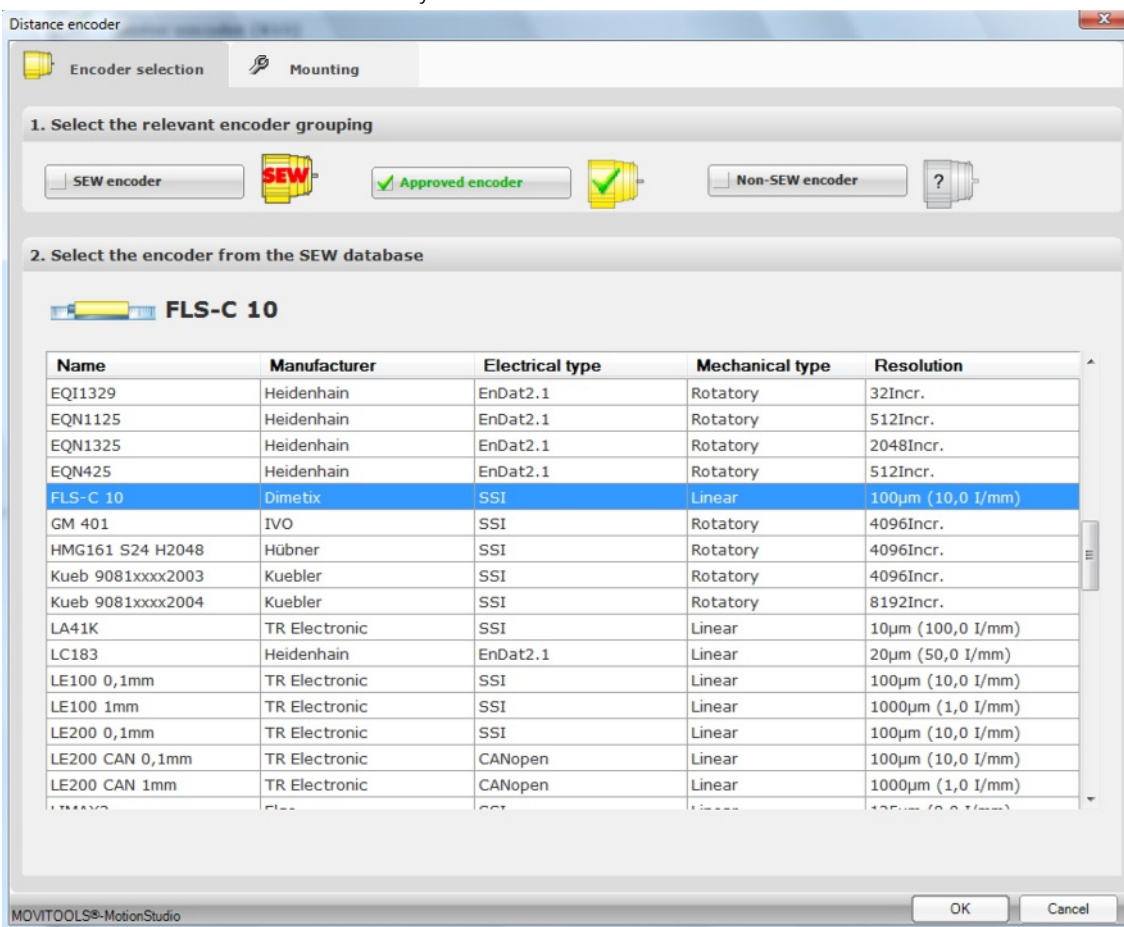

5 MOVIDRIVE® B setup for D-Series and C-Series

- Select the 'Mounting' tab, enter the traveling distance per motor revolution in μm (adjustment to the mechanic)

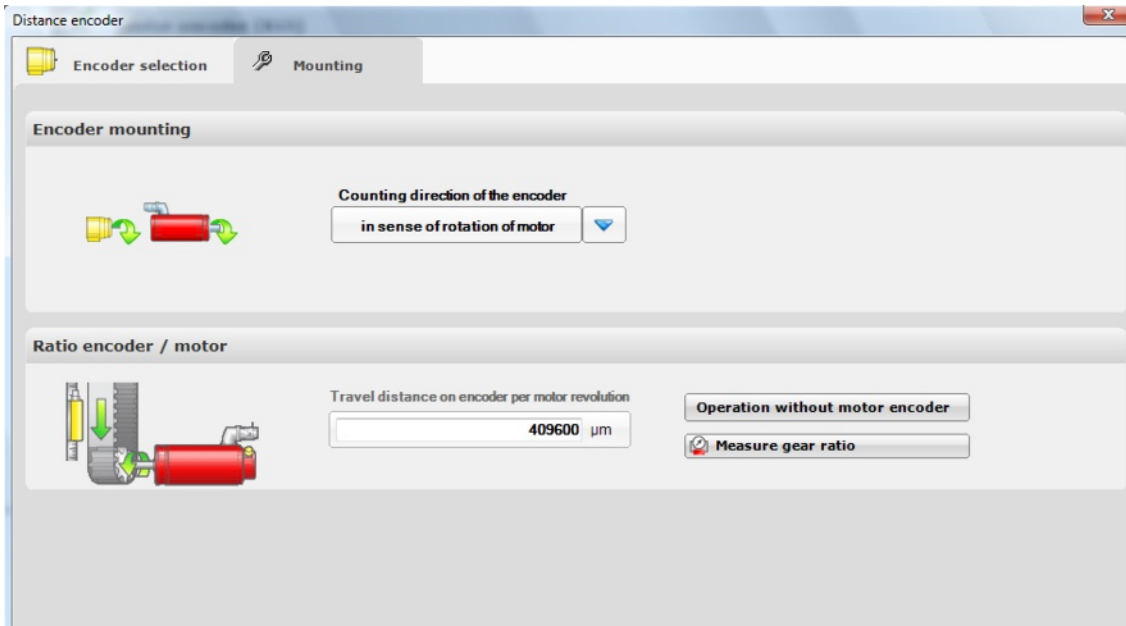

- Start-up the motor-encoder
- Switch on the position detection

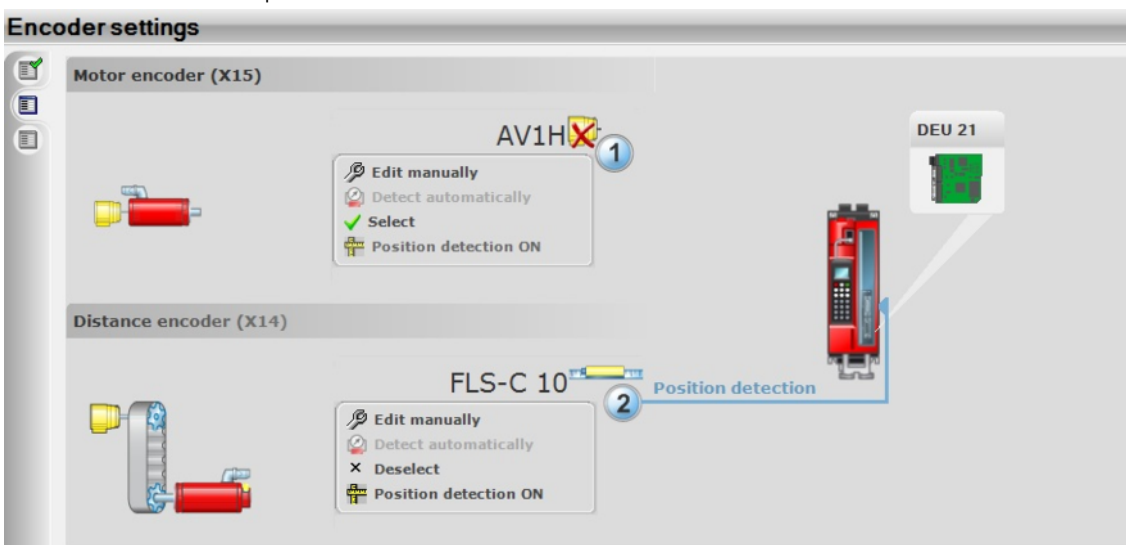

6 MOVIAXIS® setup for D-Series and C-Series

- In GUI: drag XGS Card on slot 3 and drop it to distance encoder 1

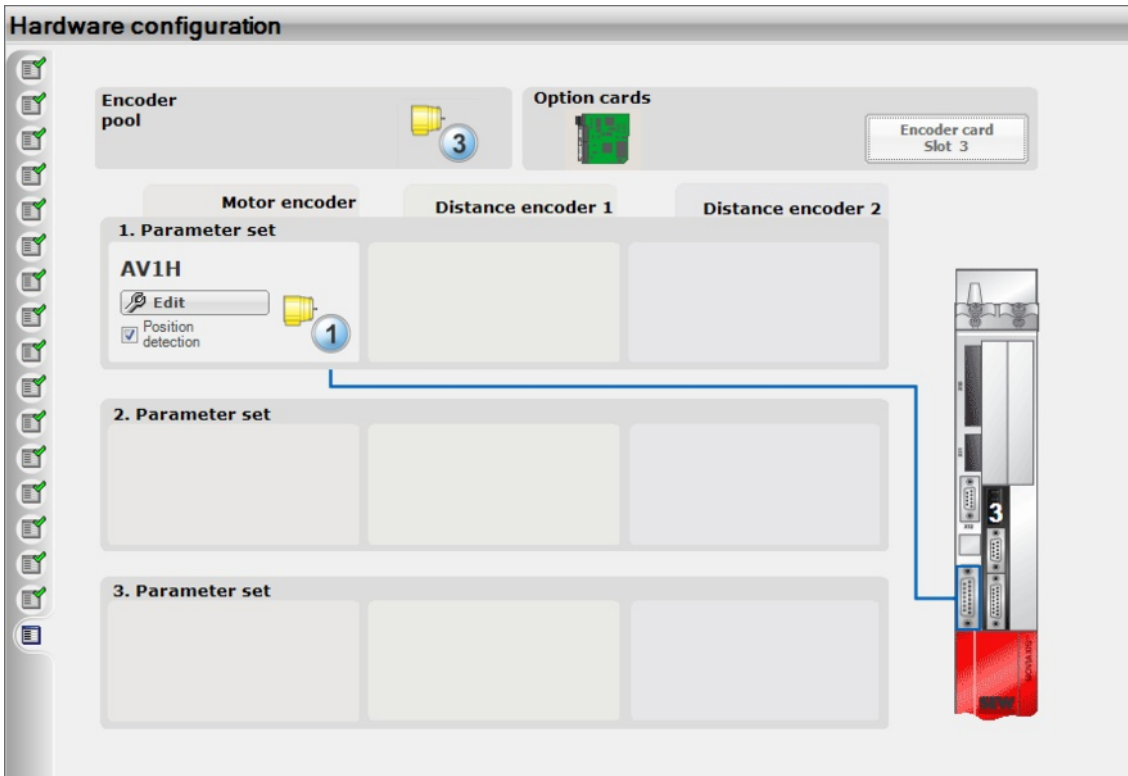

- Edit the encoder

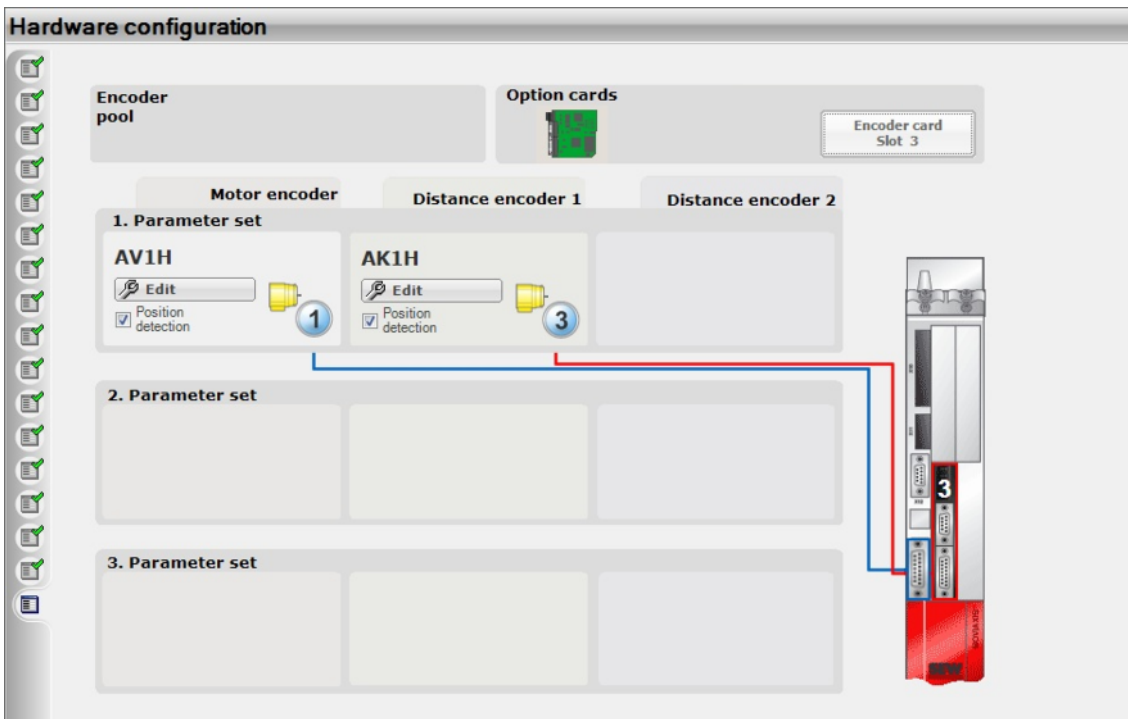

6 MOVIAXIS® setup for D-Series and C-Series

- Select 'FLS-C 10 Dimetix' as your encoder

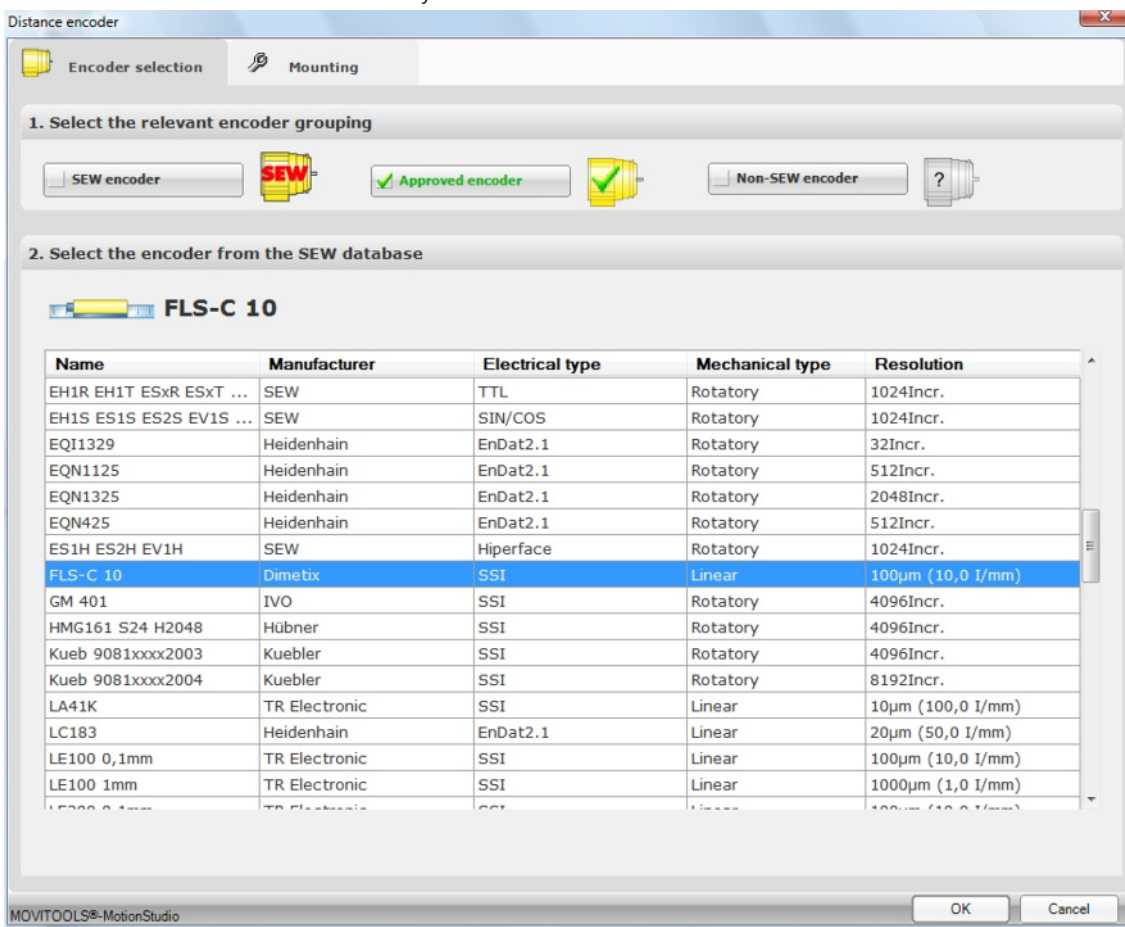

- Select the 'Mounting' tab, enter the traveling distance per motor revolution in µm (adjustment to the mechanic)

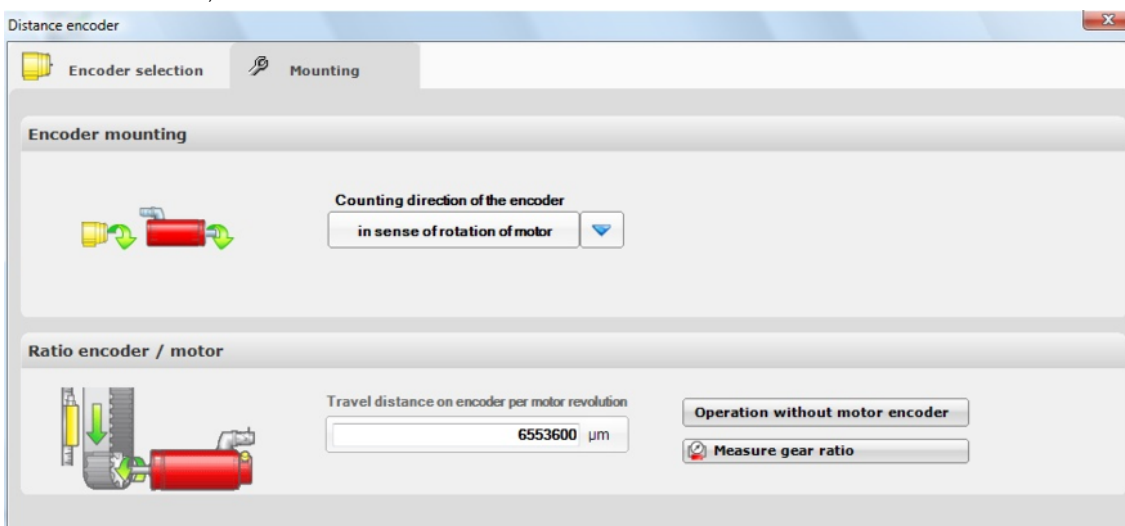

- Switch the position measurement system to external.

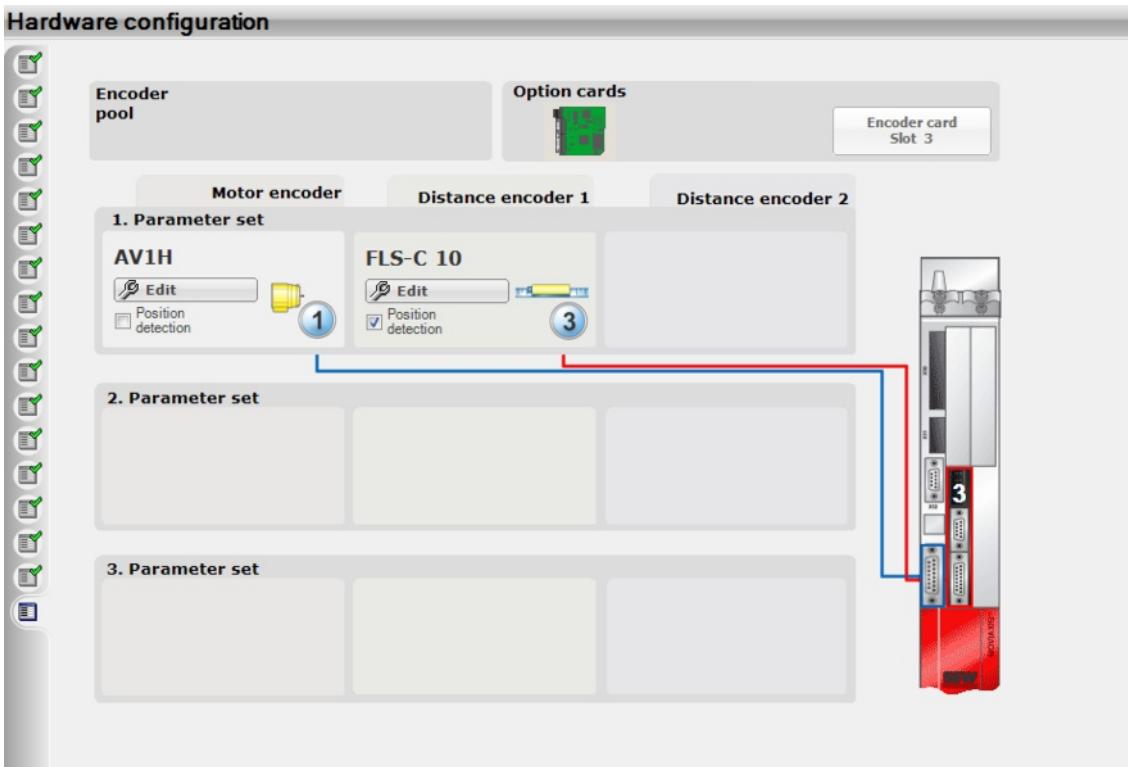

- Start-up the motor encoder.

